

Sticlărie & Laborator echipamente / Glassware & Lab equipment / أواني المختبر الزجاجية و معدات المختبرات

Pahar / Beaker

دورق

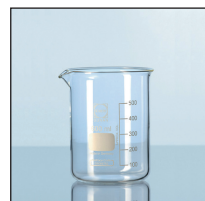

	V (mL)
S001001	5
S001002	10
S001003	25
...	...
S001015	10000

Pahar PP / Beaker PP

دورق PP



	V (mL)
S001021	10
S001022	25
S001023	50
...	...
S001034	5000

Cană de măsurare / Measuring jug

إبريق قياس



	V (mL)
S001101	50
S001102	100
S001103	250
...	...
S001108	5000

Cilindru gradat / Measuring cylinder

اسطوانة القياس

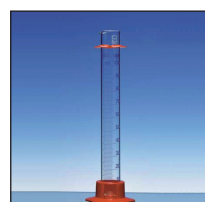

	V (mL)
S001301	10
S001302	25
S001303	50
...	...
S001307	1000

Cilindru gradat PP / Measuring cylinder PP

اسطوانة القياس PP



	V (mL)
S001200	10
S001201	25
S001202	50
...	...
S001207	2000

Erlenmeyer reductie / Erlenmeyer narrow

إرلنماير ضيق

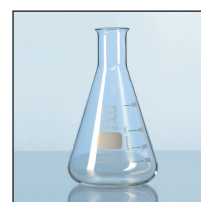

	V (mL)
S001041	25
S001042	50
S001043	100
...	...
S001050	5000

Erlenmeyer larg / Erlenmeyer wide

إرلنماير واسع

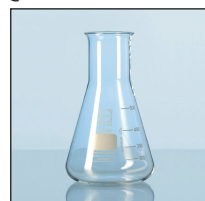

	V (mL)
S001061	25
S001062	50
S001063	100
...	...
S001067	2000

Flacon volumetric / Volumetric flask

دورق حجمي / معياري

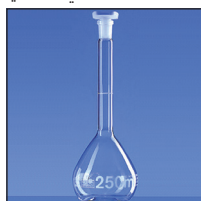

	V (mL)
S001401	5
S001402	10
S001403	25
...	...
S001410	5000

Flacon PP volumetric / Volumetric flask PP

دورق حجمي / معياري PP

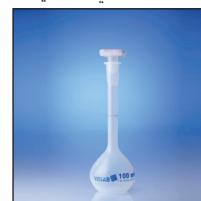

	V (mL)
S001081	10
S001082	25
S001083	50
...	...
S001087	1000

Flacon reductie / Flask narrow

قارورة ضيقة



	V (mL)
S001121	50
S001122	100
S001123	250
...	...
S001131	10000

Flacon larg / Flask wide

قارورة واسعة



	V (mL)
S001141	50
S001142	100
S001143	250
...	...
S001146	2000

Flacon fund rotund / Flask round bottom

القارورة مستديرة القاع



	V (mL)
S001161	50
S001162	100
S001163	250
...	...
S001173	12000

Inel / Ring

حلقة



	Ø (mm)
S001181	30 / 80
S001182	60 / 110
S001183	90 / 140
...	...
S001184	180 / 240

Dop cauciuc / Rubber stopper

سدادة مطاطية



	Ø (mm)
S001221	3,5 / 6,5
S001222	5 / 9
S001223	8 / 12
...	...
S001244	94 / 107

Dop cu gaura opturare / Stopper with hole

سدادة بفتحة

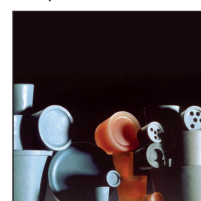

	Ø (mm)
S001251	×1
S001252	×2
-	-
-	-
-	-

Dop Steri / Steri-stopper

سدادة ستيري



	Ø (mm)
S001261	10,5 / 11,5
S001262	9,5 / 11,5
S001263	12,5 / 14,5
...	...
S001282	47 / 48

Perii / Brushes

الفرش



	Ø × ↑ (mm)
S001321	5 × 100
S001322	10 × 60
S001323	10 × 50
...	...
S001332	30 × 150

Support uscare / Draining rack

رف تجفيف



	DESCR.
S001341	32× Λ
S001342	55× Λ
S001343	72× I
-	-

Epruvetă / Test tube

أنبوب اختبار

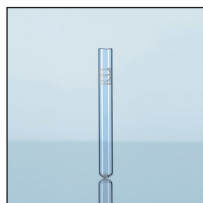

📖	Ø × ↑ (mm)
S002301	10 × 100
S002302	12 × 100
S002303	14 × 130
S002304	16 × 160
S002305	18 × 180

Suport epruvetă / Test tube stand

حامل أنبوب الاختبار



📖	DESCR.
S002401	2 × 6
S002400	2 × 10
S002402	2 × 12
...	...
S002406	10 × 10

Biuretă / Burette

سحاحة



📖	V (mL)
S001361	10
S001362	15
S001363	25
S001364	50
-	-

Biurete digitale / Digital burette

سحاحة رقمية



📖	V (mL)
S001381	25
S001382	50
-	-

Flacon de sticlă / Lab bottle glass

زجاجة مختبر



📖	V (mL)
S002000	30
...	...
S002005	1000
S002101	30
...	...
S002105	1000

Flacon de plastic / Lab bottle plastic

زجاجة بلاستيكية معملية



📖	V (mL)
S002200	30
...	...
S002205	1000
S002220	30
...	...
S002225	1000

Balon / Carboy

كاربوي



📖	V (L)
S001421	5
S001422	10
S001423	25
S001424	60
S001425	×

Sticla / Wash bottle

زجاجة غسيل



📖	V (mL)
S002501	125
S002502	250
S002503	500
S002504	1000
-	-

Sticla cu pulverizator / Spray bottle

زجاجة غسيل رش



📖	V (mL)
S002601	250
S002602	500
S002604	1000
-	-

Picurător / Dropper

قطارة



📖	V (mL)
S001441	10
S001442	25
S001443	50
-	-

Borcan / Jar

بطرمان



📖	V (mL)
S001461	15
S001462	30
S001463	60
...	...
S001467	1000

Farfurii aluminiu / Aluminium dishes

أطباق الألمنيوم



📖	Ø × ↑ (mm)
S001481	51/64 × 13
S001482	78/96 × 24
-	-

Palnie sticla / Funnel glass

قمع زجاجي

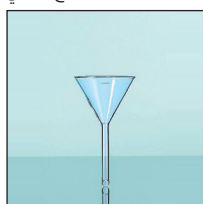

📖	Ø × ↑ (mm)
S001521	35 × 60
S001522	45 × 80
S001523	55 × 95
...	...
S001528	200 × 325

Palnie PP / Funnel PP

قمع PP

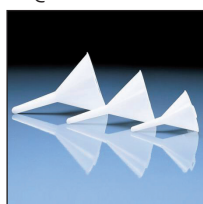

📖	Ø × ↑ (mm)
S001541	30 × 45
S001542	30 × 47
S001543	40 × 65
...	...
S001548	150 × 220

Tava PP / Tray PP

صينية PP

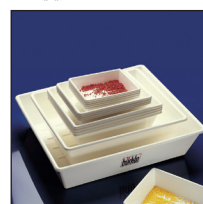

📖	→↗ (mm)
S001561	130 × 180
S001562	180 × 240
S001563	240 × 300
...	...
S001566	500 × 700

Tava otel inoxidabil / Tray stainless steel

صينية ستانلس ستيل



📖	→↗ (mm)
S001581	170 × 110
S001582	200 × 120
S001583	220 × 140
...	...
S001590	520 × 340

Pasteurpette / Pasteurpette

المعجون



📖	V (ml)
S001641	0,2
S001642	1,0
S001643	1,5
...	...
S001647	10,0

Pipetă gradată / Graduated pipette

ماصة متدرجة

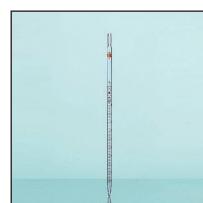

📖	V (mL)
S001500	0,5
S001501	1
S001502	2
...	...
S001506	50

Pipetă volumetrică / Volumetric pipette

ماصة حجمية

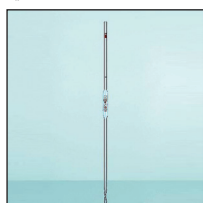

📖	V (mL)
S001600	0,5
S001601	1
S001602	2
...	...
S001610	100

Bec / Bulb

مصباح



📖	V (ml)
S001661	5
S001662	10
S001663	28
...	...
S001667	225

Bec de siguranță / Safety pipette filler

حشو ماصة آمن



📖	V (mL)
S001701	10
S001702	100
-	-

Pipeta borcan / Pipette jar

جرة الماصة



📖	Ø × ↑ (mm)
S001681	83 × 430
-	-

Micropipeta / Automatic pipette (adjust. vol.)

ماصة اتوماتيك



📖	V (μL)
S001721	0,2 ... 2
S001722	1 ... 10
S001723	2 ... 20
...	...
S001729	1000 .. 5000

Sfaturi / Tips

شريط لازق



📖	V (μL)
S001741	0,2 ... 2
S001744	2 ... 200
S001746	100 ... 1000
S001749	10 ³ ... 5000
-	-

Dispensette / Dispensette

ديسبنسي



📖	V (mL)
S001761	0,05 ... 5
S001762	0,2 ... 2
S001763	0,5 ... 5
...	...
S001767	10 ... 100

Linguriță / Spoon

ملعقة



📖	→ ↗ (mm)
S001781	150 × 5
S001782	200 × 5
S001783	120 × 23
...	...
S001788	300 × 41

Chiuretă / Scoop

مغرفة



📖	V (mL)
S001821	2
S001822	5
S001823	10
...	...
S001829	1000

Spatula / Spatula

الملعقة المسطحة



📖	→ ↗ (mm)
S001841	130 × 9
S001842	150 × 9
S001843	185 × 9
...	...
S001846	300 × 16

Bisturiu / Scalpel

مشرط



📖	DESCR.
S003101	10
S003102	11
S003103	12
...	...
S003109	24

Foarfecă / Scissors

مقص



📖	↑ (mm)
S002901	130
S002902	115
S002903	115
-	-

Ac / Needle

إبرة



📖	↑ (mm)
S001861	140
S001862	
S001863	
-	-

Pensete / Pincers

كماشة



📖	↑ (mm)
S003001	115
S003002	160
S003003	115
...	...
S003005	160

Set disecție / Microscopy instr. set

مجموعة أدوات تشريح



📖	DESCR.
S002801	9 P.
S002802	15 P.
-	-

Ac de biopsie / Biopsy needle

إبرة الخزعة

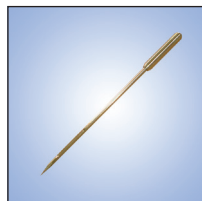

📖	↑ (mm)
S001881	200
-	-

Cornier pipelle / Cornier pipelle

كورنير بيبيل

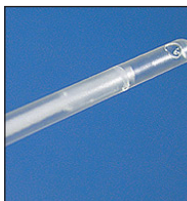

📖	Ø × ↑ (mm)
S001882	235 × 31
-	-

Arzător cu gaz Bunsen / Bunsen gas burner

موقد غاز بنسن



📖	DESCR.
S001921	Nat.
S001922	Propane
-	-

Fisiere / Slides

الشرائح



📖	→ ↗ (mm)
S003201	76 × 26
S003202	
-	-

Sticla acoperire / Cover glasses

غطاء نظارات

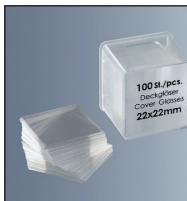

📖	→ ↗ (mm)
S003301	20 × 20
...	...
-	-

Filtru de seringă / Syringe filter

مرشح حقنة



📖	μm
S001941	0,20
S001942	0,45
S001943	0,80
S001944	1,20
S001945	5,00

Filtru aer / Air filter

مرشح الهواء



📖	μm
S001961	0,20
S001962	0,45
-	-

Filtru Susp. sol. / Suspended solids filter

مرشح المواد الصلبة المعلقة



📖	V (ml)
S001981	300 (1000)
S001982	3 × 300
📖 p. 107	

Sita / Sieve

غربال



📖	μm
S002241	20
S002242	25
S002243	32
...	...
S002282	900

Agitator magnetic / Magnetic stirrer

محرك مغناطيسي



	V (L) / Ø (mm)
S002321	0,8 / 100
S002322	0,25 / 80
S002323	1 / 115
...	...
S002326	20 / 135

Bar magnetică / Magnetic stirring bar

شريط التحريك المغناطيسي

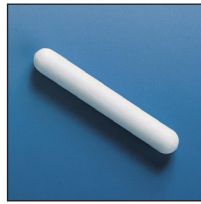

	Ø × ↑ (mm)
S002341	6 × 10
S002342	6 × 15
S002343	6 × 20
...	...
S002352	9 × 80

Desicator / Desiccator

مجفف



	Ø × ↑ (mm)
S002361	100 × 187
S002362	150 × 252
S002363	200 × 309
S002364	250 × 357
S002365	300 × 433

Cuptor / Oven

فرن



	V (L)
S002421	14
S002422	32
S002423	39
...	...
S002429	749

Incubator frigorific / Incubator

حاضنة



	V (L)
S002381	32
S002382	39
S002383	53
...	...
S002387	749

Baie apa / Water bath

حمام مائي



	V (L)
S002541	7
S002542	10
S002543	14
...	...
S002546	45

Baie ultrasonic / Ultrasonic bath

حمام بالموجات فوق الصوتية



	V (L)
S002561	3,0
S002562	5,5
S002563	9,7
...	...
S002566	58,0

Frigider / Refrigerator

ثلاجة



	V (L)
S002581	130
S002582	230
S002583	329
S002584	520
-	-

Congelator / Freezer

فريزر



	V (L)
S002621	133
S002622	421
S002623	490
-	-

Cutie de răcire / Cooling box

صندوق تبريد



	V (L)
S002641	10
S002642	17
S002643	24
S002644	28
S002645	32

Autoclavă / Autoclave

فرن الضغط



	V (L)
S002661	23
...	...
S002667	200
S002681	40
...	...
S002688	150

Deionizer PCF / Deionizer PCF

مؤين PCF



	↑ (")
S002721	10
S002722	20
S002723	20 BB
☞ carter / housing / portafiltro p. 61	

Osmoza inversa / Reverse osmosis

تناضح عكسي



	Q (lpm)
S002730	0,13
S002731	1,5
☞ ind. app. p. 71	

Distilator / Water still

مقطر ماء



	Q (L/h)
S002741	2
S002742	4
S002743	2
...	...
S002746	12

Mojar & Pistil / Mortar & Pestle

مدقة الهاون



	Ø (mm)
S002701	65
S002701	90
S002703	130
...	...
S00207	330

Concator - Dispergator / Crusher - Disperser

كسارة - مشتت



	⚡ (W)
S001621	75
S001622	300
S001623	300
S001624	700
S001625	1500

Ochelari / Glasses

نظارات



	DESCR.
S002761	I
S002762	II
S002763	III
-	-

Masca / Mask

قناع



	DESCR.
S002781	I
S002782	II
S002783	III
-	-

Manusi latex / Latex gloves

جاوتي مطاطي



S002821	7
S002822	8
S002823	9
S002824	10
-	-

Halat laborator / Lab coat

معطف المختبر



S002831	S
...	...
S002836	XXXL
S002841	cot.

Capac bufant / Bouffant cap

مغطاء متنفخ



	DESCR.
S002861	PP Ø 53 mm
-	-

Husa pantof / Overshoe

جرموق



DESCR.	
S002881	PP 165 × 400
-	-

Spalator ochi / Eye-wash

غسل العين



V (mL)	
S002921	1 × 500
S002922	2 × 500
-	-

Dus / Shower

دش



DESCR.	
S002941	ϕ 3/4" → 625 mm
-	-

Mobilier / Furniture

اثاث



DESCR.	
S002961	ⓘ
-	-

Dulap de siguranță / Safety cupboard

خزانة أمان



→↑↑ (mm)	
S002981	500 × 500
S002982	930 × 500
S002983	1320 × 800
↑ 1950-2000 mm	

Rezervor de retenție / Retention tank

خزان الاحتفاظ

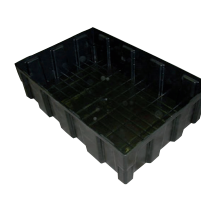

→↑↑ (mm)	
S003021	1210
S003022	810
...	330
S003032	
ⓘ ...	

IBC container pagina 19 / IBC container page 19 / حاويات IBC صفحة 19

Microscop & Stereozoom

Opțiuni : USB ocular video color, adaptor aparat de fotografiat digital, ... Alte modele (trinocular, iluminat Köhler, ...), disponibil la cerere. ⚡ 230 V/50 Hz~1.

Microscope & Stereozoom

Options : USB color video ocular, digital camera adapter, ... Other models (trinocular, Köhler lighting, ...) available on request. ⚡ 230 V/50 Hz~1.

ميكروسكوب و ستريوزوم

الخيارات: فيديو بصري USB ملون، محول كاميرا رقمية، ... موديلات أخرى (ثلاثية العين، إضاءة كوهلر، ...) متوفرة عند الطلب. ⚡ 230 فولت / 50 هرتز ~ 1.

DESCR. / وصف	obj. / عدسة	ilum. / light / إضاءة
S003601	4x, 10x, 40x, 100x	hal. 20 W
S004050	2x, 4x	LED

camere numărare pagina 158 / Counting chambers page 158 / عد الشرائح صفحة 158

Imagistica de diagnostic veterinar

Sisteme de rezonanta magnetica sau imagistica cu ultrasunete pentru determinarea sexului peștilor sau în stadiul de maturitate (gonadele...).

Veterinary diagnostic imaging

Magnetic resonance or ultrasound imaging systems for fish sex determination or maturity stage (gonads, ...). Battery-operated.

التصوير التشخيصي البيطري

أنظمة التصوير بالرنين المغناطيسي أو الموجات فوق الصوتية لتحديد جنس الأسماك أو مرحلة النضج (الغدد التناسلية، ...) بطارية تعمل

DESCR. / وصف	□	📄	→↑↑ (mm)	⚖ (kg)
S006740	15.6"	📄	340 × 398 × 96 / 340	6

Criobiologie

Computer controlat sistem de congelare (0,01 ... 60 °C/min), cu conectare la container cu azot lichid (LIN), pentru conservarea la rece a spermei.

Cryobiology

Computer-controlled freezing system (0,01 ... 60°C/min), with connection to liquid nitrogen (LIN) supply container, for cold conservation of sperm.

علم الأحياء المتجمدة

نظام تجميد يتم التحكم فيه بواسطة الكمبيوتر (0,01 ... 60 درجة مئوية / دقيقة)، مع توصيله بحاوية إمداد النيتروجين السائل (LIN)، للحفاظ على الحيوانات المنوية في البرودة.

DESCR. / وصف	□	T (°C)	Vol. (l)	→↑↑ (mm)	⚖ (kg)
S005901	12"	+40 ... -180	16,4	540 × 420 × 520	29





Plancton & biofilm examinare

Numărare slide-uri și camere pentru plancton. Echipamente de manipulare : pipete Piston de prelevare a probelor (Hansen) și plancton compas (Folsom).

Plankton & biofilm examination

Counting slides and chambers for plankton. Handling equipment : Plunger sampling pipette (Hensen) and Plankton divider (Folsom).

فحص العوالق والغشاء الحيوي

عد الشرائح والغرف للعوالق. معدات المناولة: ماصة عينات الغطاس (Hensen) ومقسم العوالق (Folsom).

DESCR. / وصف	↓ (mm)	□ (mm)	■ (mm ²)
S003410 Bine / Cavity / تجويف 1x	0,6 - 0,8	15 - 18	-
S003411 Bine / Cavity / تجويف 2x			
S003400 Malassez	0,2	2 x 2,5	0,05 / 0,0025
S003401 Fuchs-Rosenthal	0,2	4 x 4	1 / 0,0625
S003402 Sedgewick-Rafter	1	10 x 10	1
S003403 McMaster	1,5	50 x 20	10 p.
S003404 Otolit / Otolith / مخدد			
S003405 Canelată / Grooved / غبار			
S006801 Bogorov 9 mL	8	80 x 50	-
S006802 Bogorov 22 mL		100 x 80	
S006804 Bogorov 39 mL	10	120 x 85	
S006851 Gollasch 6x 5,4 mL	-	100 x 80	-
S006852 Gollasch 12x 2,4 mL			
S006853 Gollasch 30x 0,8 mL			
S006901 Kolkwitz 0,5 mL	-	33 x 33	1
S006902 Kolkwitz 1,0 mL			
S007004 Tubular 5 ml	-	Ø 26/30	-
S007005 Tubular 10 ml			
S007006 Tubular 25 ml			
S007001 Utermöhl 10-25-50-100 mL			

DESCR. / وصف	DESCR. / وصف	DESCR. / وصف
S007101 Hensen 0,1 mL	S007103 Hensen 0,5 mL	S007105 Hensen 2,5 mL
S007102 Hensen 0,25 mL	S007104 Hensen 1,0 mL	S007106 Hensen 5,0 mL
S007201 Folsom 100 mL	S007202 Folsom 1 L	S007203 Folsom 2 L
S007250 ATP kit monitorizare / ATP monitoring kit / ATP مراقبة طقم		

Prelevator manual de apa & sedimente

Probe de probă (Tele-sampler), flacon de sticlă sau plastic cu mesager (Apa), gheară apucătoare (Sediment).

Manual water & sediment samplers

Sampling rod (Tele-sampler), glass or plastic bottles with messenger (Water), bottom sampler (Sediment).

أجهزة أخذ عينات المياه والرواسب اليدوية

قضب أخذ العينات (جهاز أخذ العينات عن بعد) ، زجاجات زجاجية أو بلاستيكية مع مرسال (ماء) ، جهاز أخذ العينات السفلي (الرواسب).

DESCR. / وصف	Vol. (L)	DESCR. / وصف	Vol. (L)
Apa / Water / ماء			
S007290 Tele-sampler (*)	-	S007304 Ruttner	3
S007401 Niskin	1,7	S007305 Ruttner	5
S007402 Niskin	2,5	S007551 Van Dorn	2
S007403 Niskin	5	S007552 Van Dorn	3
S007406 Niskin	8	S007553 Van Dorn	4
S007404 Niskin	10	S007554 Van Dorn	6
S007303 Ruttner	1,8	S007555 Van Dorn	8
Sediment / Sediment / الرواسب			
S008201 Van Veen	1,4	S008152 Ponar	8,2
S008202 Van Veen	5	S008001 Ekman	3
S008203 Van Veen	15	S008002 Ekman	5
S008151 Ponar	2,2	S008003 Ekman	12

(*) → 1,4 ... 4,8 m ~ 0,9 ... 3,0 m ; Ø 90 ... 120 mm

Prelevatoare apa automate

Prelevatoarele de suprafață, cu pompă peristaltică (max. înălțimea de aspirație 7-8 m), portabile (aplicarea pe teren), cu baterie. Prelevatoarele submerse disponibile în opțiunea cu sondă de măsurare Multiparametru și înregistrator de date.

Automatic water samplers

Surface samplers with peristaltic pump (max. suction height 7-8 m), portable for field application, with battery. Submerged samplers available in option with multiparameter measuring probe and data logger.

أجهزة أخذ عينات المياه الأوتوماتيكية

أجهزة أخذ العينات السطحية مزودة بمضخة تمعجية (أقصى ارتفاع للشفت 8-7 متر)، محمولة للتطبيق الميداني، مع بطارية. تتوفر أجهزة أخذ العينات المغمورة كخيار مع مسبار قياس متعدد المعلمات ومسجل بيانات.

DESCR. / وصف	Vol. (L)	→↗↑ (mm)	↑ (kg)
Suprafata / Surface / سطح			
S007910 Sucker	-	300 × 200 × 250	6,5
S007920 Simply	6,3	350 × 230 × 570	12
S007930 Soft			
S007940 Simply Duo	2 × 4	400 × 500 × 650	14
S007950 Soft Duo			
S007960 Simply Cool	15	400 × 500 × 650	16
S007970 Soft Cool			
S007980 Sigma 900	(*)	∅ 500 × ↑ 700	13
Submersibil / Submerged / المغمورة			
S007801 MultiLimnos	10 × 1	∅ 600 × ↑ 8300	25
S007811 MWS & Precise Rosette System	(**)	∅ 1400 × ↑ 1600	30 ... 100

(*): 1 × 11 L - 1 × 15 L - 1 × 21 L - 1 × 23 L - 2 × 4 L - 8 × 2,3 L - 24 × 0,575 L - 24 × 1 L

(**): 6 × - 12 × - 24 × / 1 ... 10 L

De asemenea, disponibile: prelevare de nămol, prelevare staționare ...

Also available: sludge sampler, stationary sampler...

متوفر أيضاً: جهاز أخذ عينات الحمأة، جهاز أخذ العينات الثابت...

Plase de plancton & Plase Surber

Pentru investigații limnologice și oceanografice. Din nylon poliamidă sintetic Nyltal sau Nitex. Opțiune: colector și supapă. Design personalizat la cerere.

Plankton nets & Surber net

For limnological and oceanographic investigations. Nyltal or Nitex synthetic polyamide nylon fabric. Option: collector and valve. Custom design on request.

شبكات العوالق وشبكة Surber

للتحقيقات الليمنولوجية والأوقيانوغرافية، نسيج نايلون بولياميد صناعي من Nyltal أو Nitex. الخيار: جامع وصمام. تصميم مخصص حسب الطلب.

∅ × ↑ (mm)	(μm)
Manual / يدوي	
S008351 200 × 1200	10-20-30-40-53-100-150-200-250-500
S008352 300 × 1400	
S008353 500 × 1500	
Simple / بسيط	
S008361 400 × 2730	100-150-200-250-335-500-1000
S008362 500 × 2880	
S008363 600 × 2980	
S008364 100 × 4160	
Standard / معيار	
S008301 250 × 500	55-64-70-75-80-85-90-100-120-150-177-180-200-225-250-275-300-335-405-500-780 (*)
S008302 400 × 1000	
Surber / Surber	
S008450 320 × 320	500

(*) opțiune / option / خيار : 10-15-20-25-30-36-41-48-50 μm

De asemenea disponibil / Also available / أيضا متاح :

Cone, Bongo, WP2, CalVET, Neuston, Manta, IKMT, CalCOFI, Multinet®, Boettger, Nansen, AQ

Tesatura nylon & poliester / Nylon & Polyester fabric / نسيج نايلون وبوليستر : p. 100

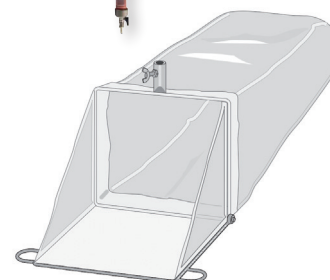
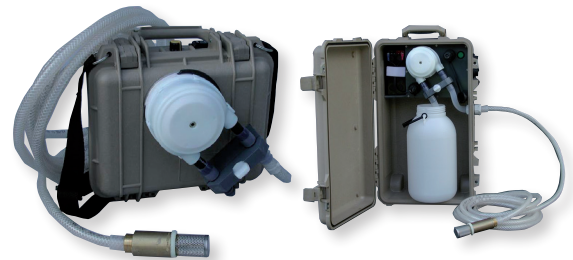



Disc Secchi

Pentru măsurarea vizibilității din apă în lacuri. Opțiune: frânghie marcată

Secchi Disc

For visibility measuring in water ponds and lakes. Option : marked rope.

قرص Secchi

لقياس مدى الرؤية في برك المياه والبحيرات. الخيار: حبل ملحوظ.

Ø (mm)	ECO	○	⊕	ISO 7027
200	S008602	S008604	S008603	S008601
300	-	S008614	S008613	S008611

Troliu de mână & Bobine

Aluminiu. Max. 15 kg de sarcină. Capac. 200 m Ø cablu 2,5mm. Incl. de numărare.

Hand winch & Spools

Aluminium. Max. load 15 kg. Cap. 200 m cable Ø 2,5 mm. Incl. counting wheel.

ونش يدوي وبكرات

الألومنيوم. الحمولة القصوى 15 كجم. سعة الكابل 200 متر Ø 2.5 ملم. عجلة العد.

📖	DESCR. / وصف	
S008701	Troliu / Winch / ونش	(15 kg / 200 m Ø 2,5 mm)
S008703	Bobina / Spool / لفه	(100 m Ø 4 mm)
S008704	Plutitoare / Floating / عائثر	(40 m Ø 4 mm)

Fluxulmetre

Rotatie (RHCM) sau prin inducție magnetică (801). Mâner vertical 3x 90/50 cm.

Current meters

Rotary vane (RHCM) or magnetic induction (801). Vertical rod 3x 90/50 cm.

عدادات تيار الماء

ريشة دوارة (RHCM) أو الحث المغناطيسي (801). قصبه رأسية 3x 90/50 سم.

📖	DESCR. / وصف	يتراوح / Gamă / Range	Ø × → (mm)
S008805	RHCM	0,100 ... 9,999 m/s ± 1 ... 5 %	-
S008810	801	-5 ... +5 m/s ± 0,5 %	40 × 90

☞ Debitmetre / Flowmeters / مقاييس التدفق : p. 142-143

De asemenea, disponibil: curent - adancimetru pentru plasa de plancton / also available : current - depth meter for plankton net /

متوفر أيضاً: مقياس التيار والعمق لشبكة العوالق

Limnimitrica ecartament placi, Stăvilare & Venturi

Placi de ecartament : material de spumă rigidă, dimensiuni de 1000 × 100 × 10 mm, greutate 250 g, gradat la fiecare 2 centimetri, numerotate în decimetri, scris negru sau roșu pe fond alb, 4 găuri pentru repara ușor. Venturi deschise pentru măsurarea debitului liber, material compozit. Stăvilare : personalizat-proiectat.

Limnimitric gauge boards, Notch weir plates & Venturi flumes

Gauge boards : rigid foam material, dimensions 1000 × 100 × 10 mm, weight 250 g, graduated every 2 centimeters, numbered in decimeters, black or red writing on white background, 4 bores for easy fix. Open flumes for free flow measurement, composite material. Notch weir plates : custom-designed.

لوحات قياس ليمنيمترية، وألواح سدود محززة، ومجاري فنتوري

ألواح القياس: مادة رغوية صلبة، الأبعاد 1000 × 100 × 10 مم، الوزن 250 جرام، مدرجة كل 2 سم، مرقمة بالديسيمتر، كتابة باللون الأسود أو الأحمر على خلفية بيضاء، 4 تجاويف لسهولة التثبيت. الأنابيب المفتوحة لقياس التدفق الحر، والمواد المركبة، ألواح السدود المسننة؛ مصممة خصيصاً.

📖	cm	col.	📖	cm	col.
S008901	00 / 09	●	S008922	00 / 09	●
S008921	09 / 00		S008918	09 / 00	●

📖	Q (m³/h)	→↗↘ (mm)	📖	Q (m³/h)	→↗↘ (mm)
S009010	7	1260 × 200 × 185	S009035	250	2583 × 400 × 395
S009015	7,6	1260 × 200 × 185	S009040	500	4889 × 550 × 470
S009020	19	1350 × 200 × 205	S009045	1000	6253 × 650 × 620
S009025	25	1350 × 200 × 205	S009050	1500	7229 × 750 × 705
S009030	100	2414 × 250 × 356	S009055	2500	10117 × 1200 × 700



Tunele de înot & Camere respirometru

Controlul vitezei de înot și de măsurare a consumului de oxigen.

Swim tunnels & Respirometer chambers

Swimming speed control and oxygen consumption measurement.

وحدات قياس السباحة وغرف التنفس

وحدات تحكم في سرعة السباحة وقياس استهلاك الأوكسجين.

📖	Vol. (L)	🐟 (g)	🏊 (cm/s)	➔ (mm)
S000000	0,17	1 - 4	3 - 37	750 x 250
S000000	1,5	4 - 12	3 - 50	1360 x 250
S000000	5	20 - 80	3 - 110	1170 x 400
S000000	10	50 - 150		1350 x 450
S000000	30	175 - 500		1470 x 530
S000000	90	450 - 1500	5 - 150	1880 x 710

① camere de odihnă, de alegere, analiza video al comportamentului ... / resting chambers, choice tanks, video behavior analysis... / غرف الاسترخاء، خزانات الاختيار، تحليل السلوك بالفيديو

Senzori de mediu & Oceanografie / Hidrologie

De asemenea, disponibile la cerere: geamanduri oceanografice, vehicule robotizate (AUV, ROV, USV, Glider, ROTV), acustică și doppler (ACDP, DVL, maree/umflare), sonare, sonde hidrografice, fluorometre, ...

Environmental sensors & Oceanography / Hydrology

Also available upon request: oceanographic buoys, robotic vehicles (AUV, ROV, USV, Glider, ROTV), acoustics and doppler (ACDP, DVL, tide/swell), sonars, hydrographic echo sounders, fluorometers, ...

أجهزة الاستشعار البيئية وعلم المحيطات / الهيدرولوجيا

تتوفر أيضًا عند الطلب: العوامات الأوقيانوغرافية، والمركبات الآلية (AUV، ROV، USV، VUA)، الصوتيات والدوبلر (ACDP، DVL، المد/التضخم)، السونار، أجهزة قياس الصدى الهيدروغرافية، أجهزة قياس الفلور، ...

📖	DESCR. / وصف	📖	DESCR. / وصف
S009110	Hydrolab HL4	S009130	NKE WiMo
S009120	Hydrolab HL7	S009140	AML-6

☞ vezi și pagina 106 / see also page 106 / انظر أيضاً الصفحة 106

Lumini BioLumen®

Sistem modular bazat pe controler central pentru fotoperioda și atenuarea luminii (MasterControl 1 ... 30 PowerPods sau ProControl 1 ... 128 PowerPods). Surse de lumină LED cu spectru (● ... ○) și unghi personalizate (60 ... 120°).

BioLumen® lighting systems

Modular system based on central controller for photoperiod and light dimming (MasterControl 1 ... 30 PowerPods or ProControl 1 ... 128 PowerPods). LED light sources with custom spectrum (● ... ○) and beam (60 ... 120°).

مصابيح BioLumen®

نظام معياري قائم على وحدة تحكم مركزية لفترة التصوير وتعتيم الضوء (MasterControl 1 ... 30 PowerPods أو ProControl 1 ... 128 PowerPods). مصادر ضوء LED مع طيف مخصص (● ... ○) وشعاع (60 ... 120 درجة)

📖	DESCR. / وصف	LED	lm (● ... ○)	➔ (mm)	W (W)
X002710	Tile	10	1060 ... 2010	198 x 198 x 40	30
X002720	MiniTile	4	300 ... 650	142 x 142 x 40	9-12
X002730	Strip	7	980 ... 2145	198 x 198 x 40	12-22
X002740	Cannon	1	2600 ... 11700	∅ 160 x 397	160

☞ vezi și pagina 193 / see also page 193 / انظر أيضاً الصفحة 193

☞ luxmetru pagina 107 / luxmeter page 107 / ضوء متر صفحة 107

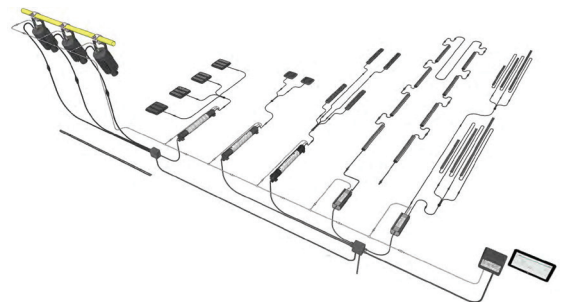
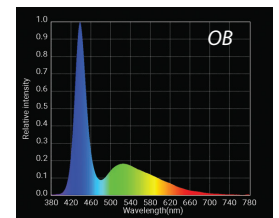
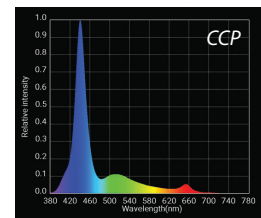
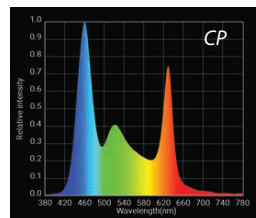
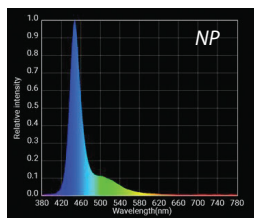
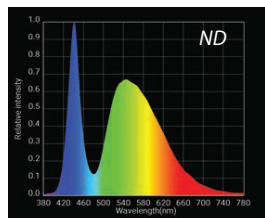

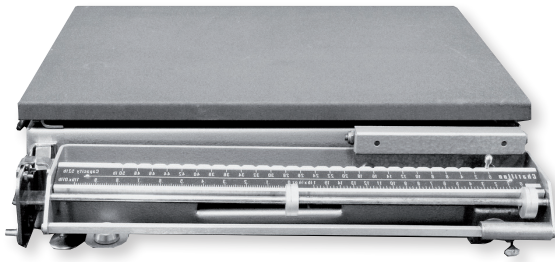

Scara banc roman

Material oțel vopsit / acoperit cu pulbere.

Roman bench scale

Painted/power-coated steel material.

بنش القياس الروماني
مصنوع من الفولاذ المطلي.

DESCR.	cap. (kg)	grad. (g)	ب (mm)	→↗↘ (mm)	↕ (kg)
S005500 PBB	52	10	425 × 292	476 × 413 × 141	10,5

Scară mecanică

Platformă din otel inoxidabil (R60, R150) sau din oțel vopsit (R300 ... R1000). Setare automată la zero. Cap rotativ.

Mechanical scale

Platform made of stainless steel (R60, R150) or painted steel (R300 ... R1000). Automatic zero setting. Rotatable head.

المقياس الميكانيكي

عبارة عن منصة مصنوعة من الفولاذ المقاوم للصدأ (R150, R60) أو الفولاذ المطلي (R300 ... R1000). وحدة ضبط تلقائية للصفر. رأس متحركة دوارة.

DESCR.	cap. (kg)	grad. (g)	ب (mm)	→↗↘ (mm)	↕ (kg)
S005515 R30	30	10	370 × 340	395 × 500 × 710	23
S005520 R60	60	20	600 × 650	600 × 890 × 1240	95
S005530 R150	150	50			

Cântar electronică de masă

Platformă din oțel inox., ~ 230 V/50 Hz~1 sau baterie / accu.

Table electronic scale

St. steel platform, ~ 230 V/50 Hz~1 or battery / accu.

مقياس الطاولة الإلكترونية

منصة فولاذية، ~ 230 فولت / 50 هرتز ~ 1 أو بطارية.

DESCR.	cap. (kg)	grad. (g)	ب (mm)	→↗↘ (mm)	↕ (kg)
FCB (standard / standard / معيار) [*]					
S004611 3K0.1	3	0,1	252 × 228	270 × 345 × 106	3
S004612 8K0.1	8	0,1			
S004613 6K0.5	6	0,5			
S004614 12K1	12	1			
S004615 30K1	30	1			
S004616 24K2	24	2			
FKB (inalta precizie / high precision / دقة عالية) [*]					
S004631 6K0.02	6	0,02	340 × 240	350 × 390 × 120	6,5
S004632 8K0.05	8	0,05			
S004639 8K0.1	8	0,1			
S004633 16K0.05	16	0,05			
S004634 16K0.1	16	0,1			
S004635 36K0.1	36	0,1			
S004636 36K0.2	36	0,2			
S004637 65K0.2	65	0,2			
S004638 65K0.5	65	0,5			
WTB-N (IP65) [*]					
S004651 1K-4N	1,5	0,2	260 × 200	286 × 316 × 127	3,2
S004652 3K-4N	3	0,5			
S004653 6K-3N	6	1			
S004654 10K-3N	15	2			
S004655 30K-3N	30	5			
FXN (IP68)					
S004103 3K-4N	3	0,5	236 × 195	240 × 280 × 120	3,2
S004106 6K-3N	6	1			
S004115 10K-3N	15	2			
S004130 30K-3N	30	5			

[*]: ecran dublu / double display / عرض مزدوج

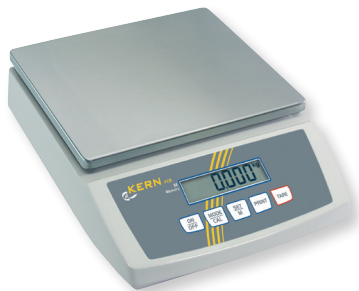
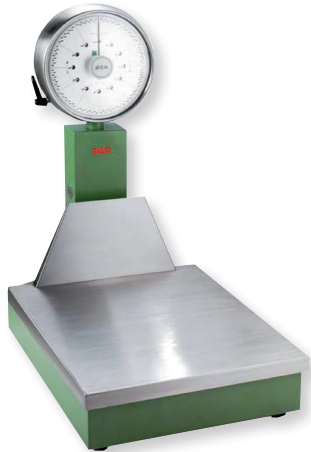

Cântar electronic de precizie

Cu cameră de protecție (PCB/PLS mici platforme ; ABS/ABJ standard).

Precision electronic scale

With protection chamber (PCB/PLS small platforms ; ABS/ABJ standard).

المقياس الإلكتروني الدقيق

مزود بغرفة الحماية (منصات صغيرة PCB / PLS ؛ معيار ABS / ABJ)

DESCR.	cap. (g)	grad. (mg)	ب (mm)	↗↖↕ (mm)	Υ (kg)
PCB [*]					
S005821	200-3	250	1	Ø 82	1,1
S005822	300-3	350			
S005823	300-2	200	10	Ø 105	
S005824	1000-2	1000			
S005826	3000-2	3500	130 × 130	163 × 245 × 65	
S005828	2000-1	2000			
S005829	6000-1	6000	100	150 × 170	
S005830	10000-1	10000			
S005831	6000-0	6000	1000		
PLS					
S005841	420-3F	420	1	Ø 110	210 × 340 × 160
S005842	720-3A	720			
S005843	1200-3A	1200			
S005846	4200-2F	4200	10	Ø 160	210 × 340 × 100
S005847	6200-2A	6200			
S005848	8000-2A	8000			
S005849	20000-1F	20000	100	200 × 175	
ABS-N/ABJ-NM					
S005860	80-4N	80	0,1	Ø 91	210 × 340 × 325
S005861	120-4N	120			
S005862	220-4N	220			
S005863	320-4N	320			

[*]: acumulator intern. (baterii reîncărcabile) / internal accu. (rechargeable battery pack) / وحدة قياس داخلية. (بطارية قابلة للشحن)

opțiune / option : masa de cântărire / weighing table

الخيار: طاولة الوزن

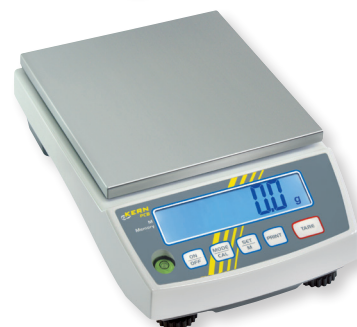

Cântar electronic platformă

Platforma oțel inox., coloana opțiune, 230 V/50 Hz~1, accu. DE-D (opt.) & SFE.

Platform electronic scale

St. steel platform, option column, 230 V/50 Hz~1, accu. DE-D (option) & SFE.

منصة ميزان الكتروني

منصة من الفولاذ المقاوم للصدأ، عمود اختياري، 230 فولت / 50 هرتز ~ 1، مركز في DE-D (اختياري) SFE.

DESCR. / وصف	cap. (kg)	grad. (g)	↗↖↕ (mm)	Υ (kg)
DE-D (standard)				
S004810	6K1D	3 6	1 2	318 × 308 × 75
S004811	15K2D	6 15	2 5	
S004812	35K5D	15 35	5 10	
S004813	35K5DL			
S004814	60K10D	30 60	10 20	318 × 308 × 75
S004815	60K10DL			522 × 403 × 90
S004816	150K20D	60 150	20 50	318 × 308 × 75
S004817	150K20DL			522 × 403 × 90
S004818	150K20DXL			650 × 500 × 105
S004819	300K50D	150 300	50 100	522 × 403 × 90
S004820	300K50DL			650 × 500 × 105

continuare pe pagina urmatoare / to be continued on next page / للمتابعة في الصفحة التالية

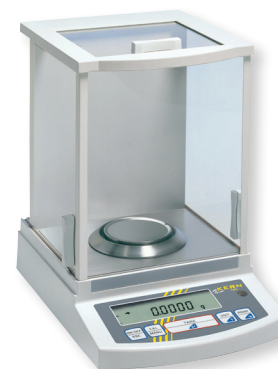



DESCR. / وصف	cap. (kg)	grad. (g)	→↗↖ (mm)	Υ (kg)
SFE (IP65)				
S004831 6K-3NM	6	2	300 × 240 × 110	6,5
S004832 10K-3NM	15	5		
S004841 10K-3LNM	15	5		
S004833 30K-2NM	30	10	400 × 300 × 128	6,5
S004835 60K-2NM	60	20	400 × 300 × 128	8
S004836 60K-2LNM			500 × 400 × 137	14,5
S004837 100K-2NM	150	50	400 × 300 × 128	8
S004838 100K-2LNM			500 × 400 × 137	14,5
S004839 100K-2XLNM			650 × 500 × 142	20
S004840 300K-1LNM	300	100		
SXS (IP68)				
S004923 6K-3M	3 6	1 2	300 × 240	7
S004925 10K-3M	6 15	2 5		
S004929 10K-3LM			15 30	5 10
S004927 30K-2M	500 × 400	22		
S004931 30K-2LM				
S004937 60K-2M	30 60	10 20	500 × 400	22
S004933 60K-2LM				
S004935 100K-2M	650 × 500	34		
S004943 100K-2LM			150 300	50 100
S004945 300K-2M				

Cântar electronic de podea

Fabricat din oțel vopsit (BFB & UIB) sau oțel inox. (BFN & UFN). Opțiuni de pod cadru groapă, rampa, balama... Palet scară mobilă. ~ 230 V/50 Hz~1.

Floor electronic scale

Made of painted steel (BFB & UIB) or st. steel (BFN & UFN). Weighing bridge options pit frame, ramp, hinge... Pallet scale mobile. ~ 230 V/50 Hz~1.

الميزان الإلكتروني الأرضي

مصنوع من الفولاذ المطلي (BFB & UIB) أو الفولاذ (BFN & UFN) مزود بخيارات إطار متحرك، منحدر، مفصلة ... مقياس حبيبات محمول ~ 230 فولت / 50 هرتز ~ 1.

DESCR. / وصف	cap. (kg)	grad. (g)	→↗↖ (mm)	Υ (kg)
Pod greutate BFB / BFB Weighing bridge / جسي الوزن BFB (IP67)				
S005020 600K-1SNM	500	200	1000 × 1000 × 85	105
S005021 600K-1NM			1500 × 1250 × 85	140
S005022 1T-4SNM	1500	500	1000 × 1000 × 85	105
S005023 1T-4NM			1500 × 1250 × 85	140
S005024 3T-3NM	3000	1000		
S005025 3T1LM			6000	2000
S005026 6T-3M	Pod greutate BFN / BFN Weighing bridge / جسي الوزن BFN (IP67)			
S005041 600K-1SM	600	200	1000 × 1000 × 90	85
S005044 1T-4SM	1500	500		
S005045 1.5T0.5M			3000	1000
S005047 3T-3M	Grinzi dze cântărie UFA / UFA Weighing beams / وزن الحزمر UFA (IP68)			
S005050 600K-1S	600	200	800 × 120 × 84	36
S005051 1.5T0.5	1500	500	1200 × 120 × 84	40
S005052 3T1	3000	1000		2000 × 120 × 90
S005053 3T-3L			6000	2000
S005054 6T-3	2000 × 160 × 115	130		
S005055 6T-3L			Balanța paleta / Pallet scale / مقياس البليت (IP67)	
S005060 UIB 600K-1	600	200	1260 × 840 × 75	65
S005061 UIB 1.5T-4	1500	500		
S005062 UIB 3T3	3000	1000		
S005070 UFN 600K200IPM	600	200		68
S005071 UFN 1.5T0.5IPM	1500	500		

ⓐ display-uri multifuncționale, ... / displays multifunction, ... / عرض متعدد الوظائف, ...

Cântar agățat

Versiune mecanică sau electronică cu baterie.

Hanging scale

Mechanical version or electronic with battery.

المقياس المعلق

وحدة ميكانيكية أو إلكترونية مع بطارية.

📖	DESCR. / وصف	cap. (kg)	grad. (g)	↔↗↖ (mm)	Υ (kg)
LK-M					
S005750	1960	10	50	173 × 50 × 259	1,0
S005751	1961	25	100		
S005752	1962	50	200		
S005753	1963	100	500		
S005754	1964	250	1000		
HDB / HCB					
S005710	5K5N	5	5	105 × 70 × 25	0,15
S005711	10K10N	10	10		
S005701	20K10	20	10	82 × 43 × 153	0,25
S005703	50K20	50	20		
S005704	99K50	100	50		
S005705	200K100	200	100		
HCN (IP65)					
S005721	50K100IP	50	100	175 × 95 × 55	0,8
S005722	100K200IP	100	200		
S005723	200K500IP	200	500		

de asemenea, sunt disponibile la cerere: alte modele și cântare de macara de mare capacitate
also available on request : other models and high capacity crane scales

متاحة أيضاً عند الطلب: نماذج أخرى وموازن الرافعات عالية السعة

Cântare mobile

Cântare auto paleți (opțiuni de imprimantă, versiunea din oțel inoxidabil, ...) și cântărire furci (Opțiuni Bluetooth, imprimantă, ...) cu baterie.

Mobile weighing

Pallet truck scales (options printer, stainless steel version, ...) and weighing forks (options Bluetooth, printer, ...) with battery.

الميزان المحمول

موازن شاحنة الحبيبات (طابعة اختيارية، من الفولاذ المقاوم للصدأ ، ...) وشوكات الوزن (بخيارات بلوتوث، طابعة ، ...) مع بطارية.

📖	DESCR. / وصف	cap. (kg)	grad. (kg)	↔↗↖ (mm)	Υ (kg)
Scara palet camion / Pallet truck scale / مقياس شاحنة الحبيبات					
S005401	VHB	2000	1	1560 × 555 × 725	120
Scara furca / Weighing forks / شوكات الميزان					
S005411	LTW	1000 2500	1 2	1150 × 133 × 625	2 × 67
S005421	Bluetooth				

Alte modele & Accesorii (display-uri, imprimante, aprobare, verificare, ...) sunt disponibile la cerere /
Other models & Accessories (displays, printers, approval, verification, ...) available on request /

أدوات القياس الأخرى المتاحة عند الطلب (بارومتر ، مقياس رطوبة ، مقياس شدة الريح ، مقياس صوت ، ...)

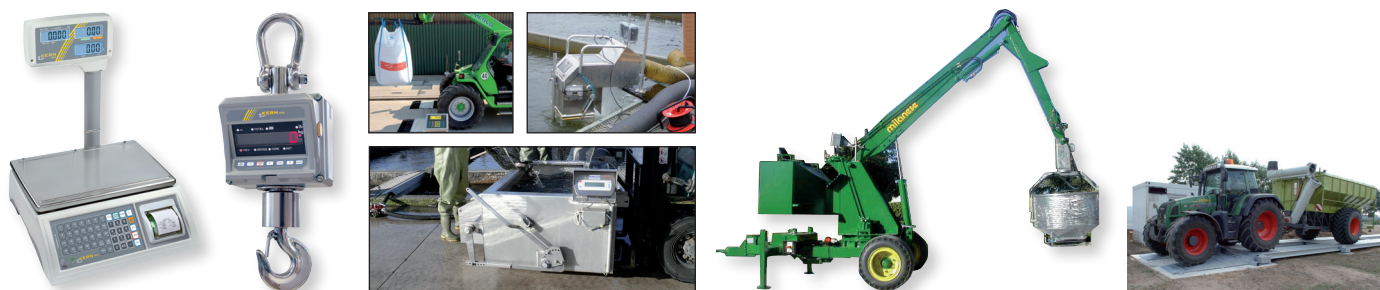

☞ pompe de pește cu cântărire pagina 80 / fish pumps with weighing page 80 / مضخات تفريغ الأسماك بها مي ان متكامل الصفحة 80 /

☞ numărare și cântărire pagina 88 / counting and weighing page 88 / العد والوزن صفحة 88 /

☞ rezervoare transport cu cântar pagina 94 / transport tanks with scale page 94 / صهاريج نقل الأسماك مع نظام وزن متكامل صفحة 94 /